

Low Voltage Electroluminescent Lamp Driver

- High Efficiency Design
- +2.2V to +5.0V Battery Operation
- DC-to-AC Converter Produces up to 220V_{P-P} for EL Display Panels
- Single Resistor Controlled Internal Oscillator
- Low Current Standby Mode Draws Less than 1μA
- Uses Small 470μH, Sub 2mm Height Coil

APPLICATIONS

- PDA's
- Pagers
- Cellular Phones
- LCD Modules
- Handheld GPS Units

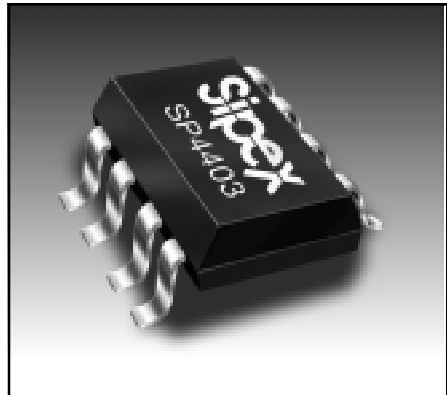

DESCRIPTION

The SP4403 is a high voltage output DC-AC inverter specifically designed to drive electroluminescent lamps to backlight liquid crystal displays, keypads, and backlit readouts used in battery operated portable equipment. The SP4403 will operate from a +2.2V to +5.0V battery source. The device features a low power shutdown mode which draws less than 100nA (typical), ideal for low power portable products. One external inductor is required to generate the high voltage AC output. One external resistor is used to select the internal oscillator frequency. The SP4403 is ideal for portable applications such as PDA's, pagers, cellular phones, and other portable applications using LCDs in dim or low light environments. The SP4403 is offered in 8 pin MSOP packages.

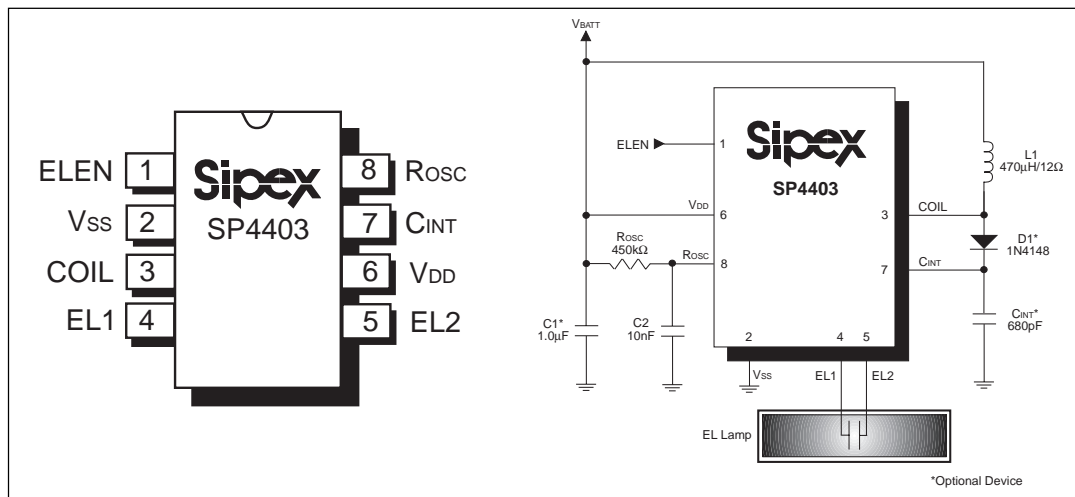

ABSOLUTE MAXIMUM RATINGS

These are stress ratings only and functional operation of the device at these ratings or any other above those indicated in the operation sections of the specifications below is not implied. Exposure to absolute maximum rating conditions for extended periods of time may affect reliability.

Power Supply, V_{BATT}7.0V
 Input Voltages, ELEN (pin 1).....-0.5V to ($V_{DD}+0.5V$)
 Lamp Outputs.....250V_{P-P}
 Operating Temperature.....-40°C to +85°C
 Storage Temperature.....-65°C to +150°C

Power Dissipation Per Package
 8-pin MSOP (derate 4.85mW/°C above +70°C).....400mW

STORAGE CONSIDERATIONS

Storage in a low humidity environment is preferred. Large high density plastic packages are moisture sensitive and should be stored in Dry Vapor Barrier Bags. Prior to usage, the parts should remain bagged and stored below 40°C and 60%RH. If the parts are removed from the bag, they should be used within 48 hours or stored in an environment at or below 20%RH. If the above conditions cannot be followed, the parts should be baked for four hours at 125°C in order to remove moisture prior to soldering. Sipex ships product in Dry Vapor Barrier Bags with a humidity indicator card and desiccant pack. The humidity indicator should be below 30%RH.

The information furnished by Sipex has been carefully reviewed for accuracy and reliability. Its application or use, however, is solely the responsibility of the user. No responsibility of the use of this information become part of the terms and conditions of any subsequent sales agreement with Sipex. Specifications are subject to change without no responsibility for any infringement of patents or other rights of third parties which may result from its use. No license or proprietary rights are granted by implication or otherwise under any patent or patent rights of Sipex Corporation.

SPECIFICATIONS

$V_{BATT} = 3.0V$, $T_{AMB} = 25^{\circ}C$, $L1 = 470\mu H/12\Omega$, $R_{OSC} = 450k\Omega$, $C_{LAMP} = 15nF/35nF$, $C_{INT} = 680pF$, $C_1 = 1.0\mu F$, and $C_2 = 10nF$ unless otherwise noted.

PARAMETER	MIN.	TYP.	MAX.	UNITS	CONDITIONS
Supply Voltage, V_{DD}	2.2	3.0	5.0	V	
Supply Current, I_{DD}		1.5 3.8	3.0 6.0	mA	$V_{DD} = V_{COIL} = 3.0V$ $V_{DD} = V_{COIL} = 5.0V$
Supply Current, $I_{COIL} + I_{DD}$		45 65	65 95	mA	$V_{DD} = V_{COIL} = +3.0V$ $V_{DD} = V_{COIL} = +5.0V$
Coil Voltage, V_{COIL}	V_{DD}		9.0	V	
ELEN Input Voltage, V_{ELEN} LOW: EL off HIGH: EL on	-0.25 $V_{DD} * 0.61$ 1.7V	0 V_{DD}	0.25V $V_{DD} + 0.25$	V	$V_{DD} = 2.8V - 5.0V$ $V_{DD} = 2.2V - 2.8V$
Shutdown Current, $I_{SD} = I_{COIL} + I_{DD}$		0.05	1.0	μA	$V_{DD} = V_{COIL} = 5.0V$
INDUCTOR DRIVE					
Coil Frequency, f_{COIL}	40.9	51.2	64.0	kHz	
Coil Duty Cycle	85	90	95	%	
Peak Coil Current, $I_{PK-COIL}$			85	mA	
EL LAMP OUTPUT					
EL Lamp Frequency, f_{LAMP}	330	400	510	Hz	$V_{DD} = V_{COIL} = 2.2V$ to 5.0V
Peak to Peak Output Voltage, V_{PP}	170 170	195 200		V_{PP}	$V_{DD} = V_{COIL} = +3.0V$, $C_{LAMP} = 15nF$ $V_{DD} = V_{COIL} = +5.0V$, $C_{LAMP} = 35nF$

PINOUT

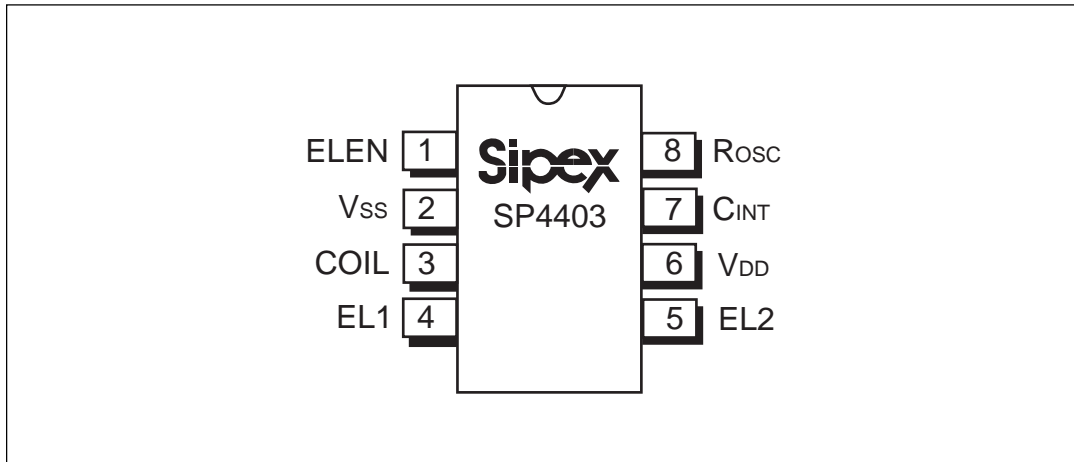

PIN ASSIGNMENTS

Pin Name	Pin Number	Description
1	ELEN	Electroluminescent Lamp Enable. When driven HIGH, this input pin enables the EL driver output EL1 and EL2 (pins 4 and 5, respectively) to the EL lamp.
2	V _{SS}	Power Supply Common. Connect to the lowest circuit potential, typically ground.
3	COIL	Coil. The inductor for the EL lamp is connected from V _{BATT} to this input pin.
4	EL1	Electroluminescent Lamp. This is a lamp driver output pin to connect to the EL lamp.
5	EL2	Electroluminescent Lamp. This is a lamp driver output pin to connect to the EL lamp.
6	V _{DD}	Positive Battery Power Supply. Connect such that $+2.2V < V_{DD} < +5.0V$.
7	C _{INT}	Integrating Capacitor. Connecting a fast recovery diode from COIL (pin 3) to this input pin increases the light output of the EL lamp. By connecting a capacitor (0.1μF) from this pin to ground, the designer can alter the sawtooth wave output at EL1 and EL2 (pins 4 and 5, respectively) to a square wave output, typically 70V _p .
8	R _{OSC}	Oscillator Resistor. Connecting a 450kΩ resistor to this input pin sets the frequency of the internal clock.

DESCRIPTION

The SP4403 contains a DC-AC inverter that can produce an AC output of up to $220V_{PP}$ from a $+2.2V$ to $+5.0V$ input voltage. An internal block diagram of the SP4403 can be found in *Figure 1*.

The SP4403 is built on Sipex's dielectrically isolated BiCMOS process that provides the isolation required to separate the high voltage AC signal used to drive the EL lamp from the low voltage logic and signal processing circuitry. This ensures latch-up free operation in the interface between the low voltage CMOS circuitry and the high voltage bipolar circuitry. The **SP4403** is ideal for applications driving EL lamps to backlight LCD displays, key panels, and other backlit readouts used in battery operated portable equipment.

A total of six external components are typically used in standard operation of the SP4403: an inductor, a fast recovery diode, three capacitors and a resistor. A diagram of the SP4403 in a typical application can be found in *Figure 2*.

Electroluminescent Technology

An EL lamp is basically a strip of plastic that is coated with a phosphorous material which emits light (fluoresces) when a high voltage ($>40V$) which was first applied across it, is removed or reversed. Long periods of DC voltages applied to the material tend to breakdown the material and reduce its lifetime. With these considerations in mind, the ideal signal to drive an EL lamp is a high voltage sine wave. Traditional approaches to achieving this type of waveform included discrete circuits incorporating a transformer, transistors, and several resistors and capacitors. This approach is large and bulky, and cannot be implemented in most hand held equipment. Sipex offers low power single chip driver circuits specifically designed to drive small to medium sized electroluminescent panels.

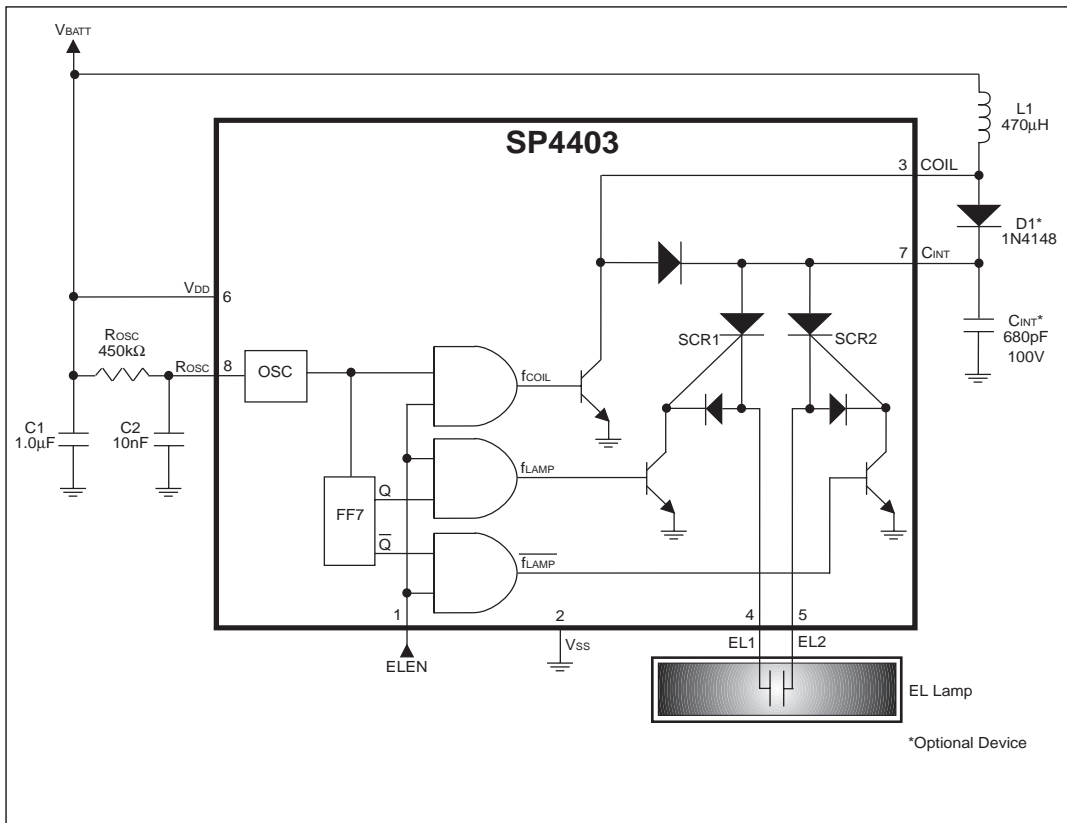

Figure 1: Internal Diagram of the SP4403

Market Applications

Electroluminescent backlighting is ideal when used with LCD displays, keypads, or other backlit readouts. Its main use is to illuminate displays in dim to dark conditions for momentary periods of time. EL lamps consume less power than LEDs or incandescent bulbs making them ideal for battery powered products. Also, EL lamps are able to uniformly light an area without creating any undesirable "hot spots" in the display.

THEORY OF OPERATION

The SP4403 is a DC-AC inverter made up of:

1. The Oscillator/Frequency Divider,
2. The Coil, and
3. The Switched H-bridge Network.

Further details of each element follow.

The Oscillator/Frequency Divider

The oscillator provides the SP4403 with an on-chip clock used to control the coil switch (f_{COIL}) and the H-bridge network (f_{LAMP} and f_{LAMP}). Although the oscillator frequency can be varied to optimize the lamp output, the ratio of f_{COIL}/f_{LAMP} will always equal 128.

Figure 1 shows the oscillator output driving the coil and the output of the oscillator with 7 flip flops driving the lamp. The suggested oscillator frequency is 50kHz ($R_{OSC} = 450k\Omega$) for f_{COIL} . The oscillator output is internally divided down by 7 flip flops to create a second internal control signal at 390Hz for f_{LAMP} .

The Coil

The supply V_{BATT} can range from +2.2V to +5.0V. V_{BATT} should not exceed the maximum coil current specification. The majority of the current goes through the coil and is typically much greater than I_{DD} .

The coil is an external component connected from V_{BATT} to pin 3 of the SP4403. Energy is stored in the coil according to the equation $E_L = 1/2LI_P^2$ where I_P , to the first approximation, is the product $I_P = (t_{ON})((V_{BATT} - V_{CE})/L)$, where t_{ON} is the time it takes for the coil to reach its peak current, V_{CE} is the voltage drop across the

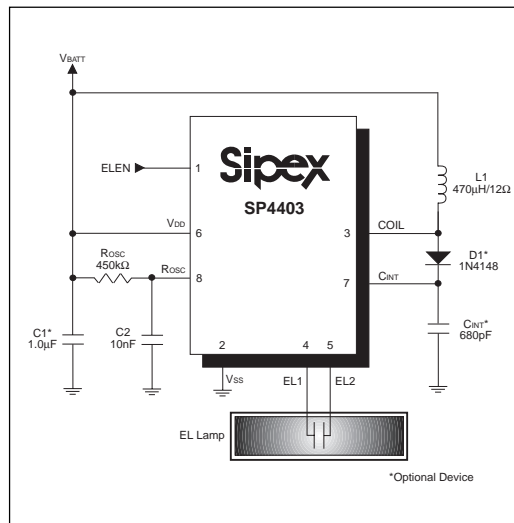

Figure 2: Typical Application Circuit for the SP4403, Set for a Square Wave Output with $C_{INT} = 0.1\mu F$

internal NPN switch transistor, and L is the inductance of the coil. When the NPN transistor switch is off, the energy is forced through an internal diode which drives the switched H-bridge network. This energy recovery is directly related to the brightness of the EL lamp output. There are many variations among coils; magnetic material differences, winding differences and parasitic capacitances. For suggested coil suppliers, refer to Page 7.

The f_{COIL} signal controls a switch that connects the end of the coil at pin 3 to ground or to open circuit. The f_{COIL} signal is a 90% duty cycle signal switching at the oscillator frequency, 50kHz. During the time when the f_{COIL} signal is HIGH, the coil is connected from V_{BATT} to ground and a charged magnetic field is created in the coil. When the f_{COIL} signal is LOW, the ground connection is switched open, the field collapses, and the energy in the inductor is forced to flow toward the high voltage H-bridge switches. f_{COIL} will send an array of charge pulses (see Figure 4) to the lamp. Each pulse increases the voltage drop across the lamp in discrete steps. As the voltage potential approaches its maximum, the steps become smaller (see Figure 3).

The Switched H-Bridge Network

The H-bridge consists of two SCR structures that act as high voltage switches. These two switches control the polarity of how the lamp is charged. The SCR switches are controlled by the f_{LAMP} signal which is the oscillator frequency divided by 128. For a 50kHz oscillator, the 7 flip flops will drive $f_{LAMP} = 390\text{Hz}$.

When the energy from the coil is released, a high voltage spike is created triggering the SCR switches. The direction of current flow is determined by which SCR is enabled. One full cycle of the H-bridge will create 128 voltage steps from ground to 80V (typical) on EL1 and EL2 (pins 4 and 5, respectively) which are 180 degrees out of phase from each other (see *Figure 5*). A differential representation of the output is shown in *Figure 6*.

Fine Tuning Performance

Circuit performance of the SP4403 can be improved with some of the following suggestions:

Increase EL Lamp Light Output: By connecting a fast recovery diode from COIL (pin 3) to C_{INT} (pin 7), the internal diode of the switched H-bridge network is bypassed resulting in an increase in light output at the EL lamp. We suggest a fast recovery diode, such as the industry standard 1N4148, be used for D1. This circuit connection can be found in *Figure 2*.

Square Wave Output Waveform to the EL Lamp: A 470pF capacitor at C_{INT} (pin 13) will act as an integrating capacitor, filtering out any coil switching spikes or ripple in the output waveform to the EL lamp (shown in *Figure 1*). A designer may change the output waveform to a square wave by using a 0.1 μF capacitor (shown in *Figure 2*) at C_{INT} (pin 13).

Printed Circuit Board Layout Suggestions:

The SP4403's high-frequency operation makes PCB layout important for minimizing ground bounce and noise. Keep the IC's GND pin and the ground leads of C_1 and C_{INT} in *Figure 2* less than 0.2in (5mm) apart. Also keep the connections to L1 (pin 3) as short as possible. To maximize output power and efficiency and minimize output ripple voltage, use a ground plane and solder the IC's V_{SS} (pin 2) directly to the ground plane.

EL Lamp Driver Design Challenges

There are many variables which can be optimized for specific applications. The amount of light emitted is a function of the voltage applied to the lamp, the frequency at which it is applied, the lamp material, the lamp size, and the inductor used. Sipex supplies characterization charts to aid the designer in selecting the optimum circuit configuration (see *Figures 7 to 14*).

Sipex will perform customer application evaluations, using the customer's actual EL lamp to determine the optimum operating conditions for specific applications. For customers considering an EL backlighting solution for the first time, Sipex is able to offer retrofitted solutions to the customer's existing LED or non-backlit product for a thorough electrical and cosmetic evaluation. Please contact your local Sales Representative for Sipex or the Sipex factory directly to initiate this valued service.

Coil Manufacturers

Hitachi Metals
Material Trading Division
2101 S. Arlington Heights Road,
Suite 116
Arlington Heights, IL 60005-4142
Phone: 1-800-777-8343 Ext. 12
(847) 364-7200 Ext. 12
Fax: (847) 364-7279

Hitachi Metals Ltd. Europe
Immernannstrasse 14-16, 40210
Dusseldorf, Germany
Contact: Gary Loos
Phone: 49-211-16009-0
Fax: 49-211-16009-29

Hitachi Metals Ltd.
Kishimoto Bldg. 2-1, Marunouchi
2-chome, Chiyoda-Ku, Tokyo,
Japan
Contact: Mr. Noboru Abe
Phone: 3-3284-4936
Fax: 3-3287-1945

Hitachi Metals Ltd. Singapore
78 Shenton Way #12-01,
Singapore 079120
Contact: Mr. Stan Kaiko
Phone: 222-8077
Fax: 222-5232

Hitachi Metals Ltd. Hong Kong
Room 1107, 11/F., West Wing,
Tsim Sha. Tsui Center 66
Mody Road, Tsimshatsui East,
Kowloon, Hong Kong
Phone: 2724-4188
Fax: 2311-2095

Murata
2200 Lake Park Drive, Smyrna
Georgia 30080 U.S.A.
Phone: (770) 436-1300
Fax: (770) 436-3030

Murata European
Holbeinstrasse 21-23, 90441
Nurnberg, Postfachanschrift
90015
Phone: 011-4991166870
Fax: 011-49116687225

Murata Taiwan Electronics
225 Chung-Chin Road, Taichung,
Taiwan, R.O.C.
Phone: 011 88642914151
Fax: 011 88644252929

Murata Electronics Singapore
200 Yishun Ave. 7, Singapore
2776, Republic of Singapore
Phone: 011 657584233
Fax: 011 657536181

Murata Hong Kong
Room 709-712 Miramar Tower, 1
Kimberly Road, Tsimshatsui,
Kowloon, Hong Kong
Phone: 011-85223763898
Fax: 011-85223755655

Panasonic.
6550 Katella Ave
Cypress, CA 90630-5102
Phone: (714) 373-7366
Fax: (714) 373-7323

Sumida Electric Co., LTD.
5999, New Wilke Road,
Suite #110
Rolling Meadows, IL, 60008 U.S.A.
Phone: (847) 956-0666
Fax: (847) 956-0702

Sumida Electric Co., LTD.
4-8, Kanamachi 2-Chrome,
Katsushika-ku, Tokyo 125 Japan
Phone: 03-3607-5111
Fax: 03-3607-5144

Sumida Electric Co., LTD.
Block 15, 996, Bendemeer Road
#04-05 to 06, Singapore 339944
Republic of Singapore
Phone: 2963388
Fax: 2963390

Sumida Electric Co., LTD.
14 Floor, Eastern Center, 1065
King's Road, Quarry Bay,
Hong Kong
Phone: 28806688
Fax: 25659600

Polarizers/transflector Mnfg.

Nitto Denko
Yoshi Shinozuka
Bayside Business Park 48500
Fremont, CA. 94538
Phone: 510 445 5400
Fax: 510 445-5480

Top Polarizer- NPF F1205DU
Bottom - NPF F4225
or (F4205) P3 w/transflector

Transflector Material
Astra Products
Mark Bogin
P.O. Box 479
Baldwin, NJ 11510
Phone (516)-223-7500
Fax (516)-868-2371

EL Lamp Manufacturers

Leading Edge Ind. Inc.
11578 Encore Circle
Minnetonka, MN 55343
Phone 1-800-845-6992

Midori Mark Ltd.
1-5 Komagata 2-Chome
Taita-Ku 111-0043 Japan
Phone: 81-03-3848-2011

Luminescent Systems inc. (LSI)
4 Lucent Dr.
Lebanon, NH. 03766-9004
Phone: (603) 643-7766
Fax: (603) 643-5947

NEC Corporation
Yumi Saskai
7-1, Shiba 5 Chome, Minato-ku,
Tokyo 108-01, Japan
Phone: (03) 3798-9572
Fax: (03) 3798-6134

Seiko Precision
Shuzo Abe
1-1, Taihei 4-Chome,
Sumida-ku, Tokyo, 139 Japan
Phone: (03) 5610-7089
Fax: (03) 5610-7177

Gunze Electronics
2113 Wells Branch Parkway
Austin, TX 78728
Phone: (512) 752-1299
Fax: (512) 252-1181

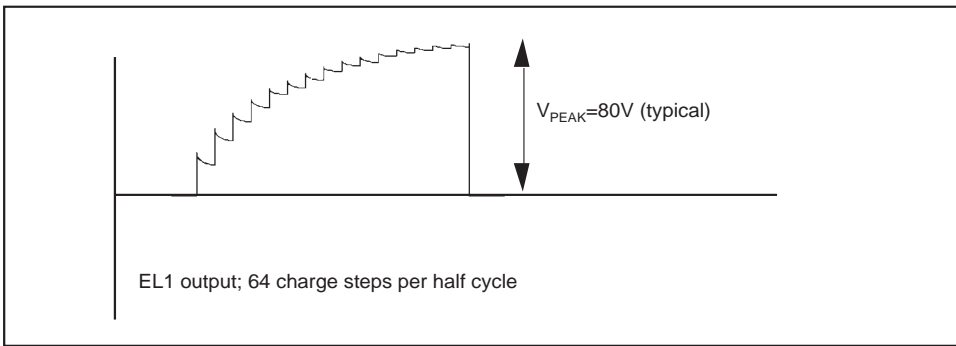

Figure 3. EL Output Voltage in Discrete Steps at EL1 Output

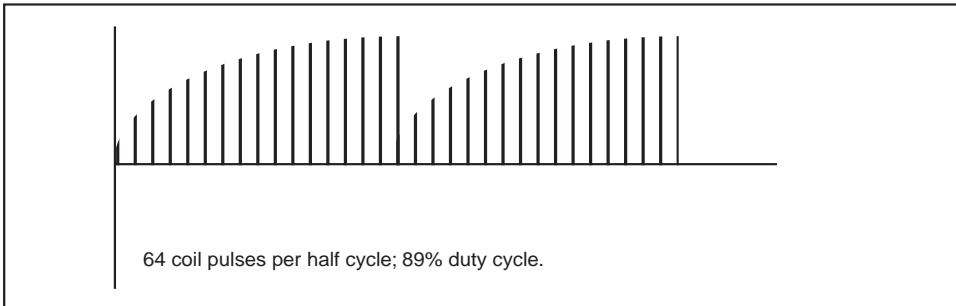

Figure 4. Voltage Pulses Released from the Coil to the EL Driver Circuitry

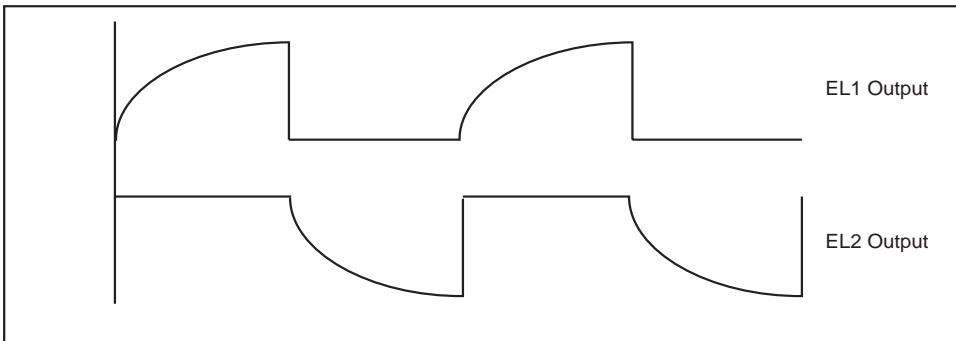

Figure 5. EL Voltage Waveforms from the EL1 and EL2 Outputs

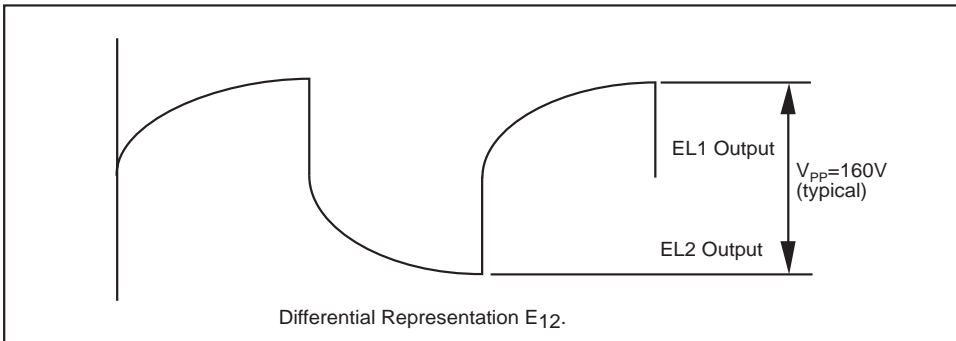

Figure 6. EL Differential Output Waveform of the EL1 and EL2 Outputs

The following performance curves are intended to give the designer a relative scale from which to optimize specific applications. Absolute measurements may vary depending upon the brand of components chosen.

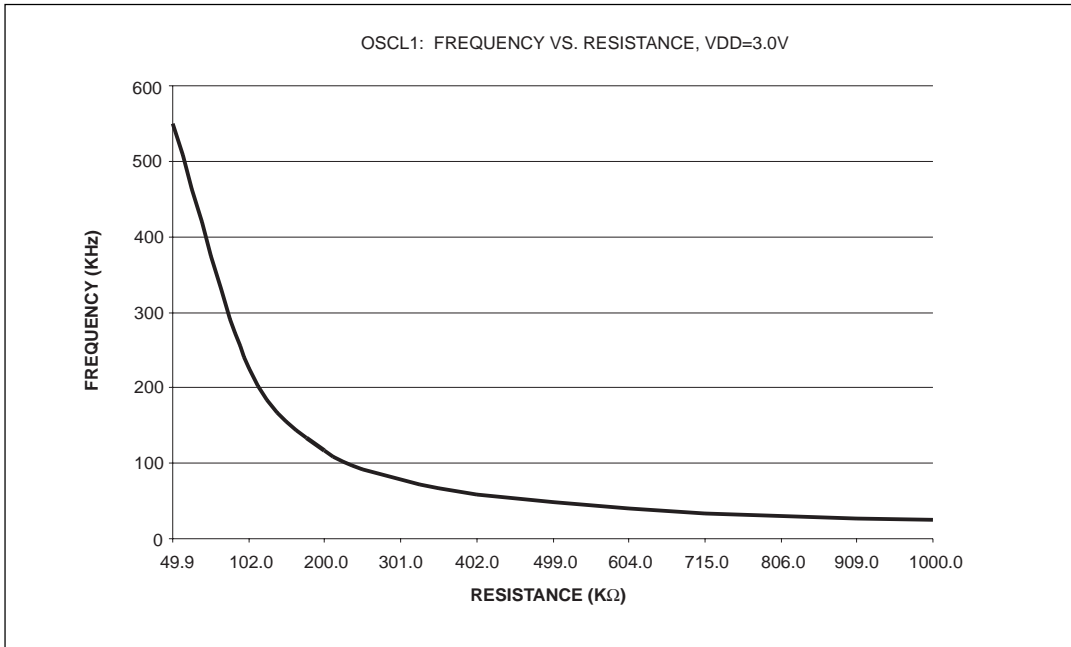

Figure 7: Oscillator Frequency vs R_{OSC} $V_{DD}=3.0V$

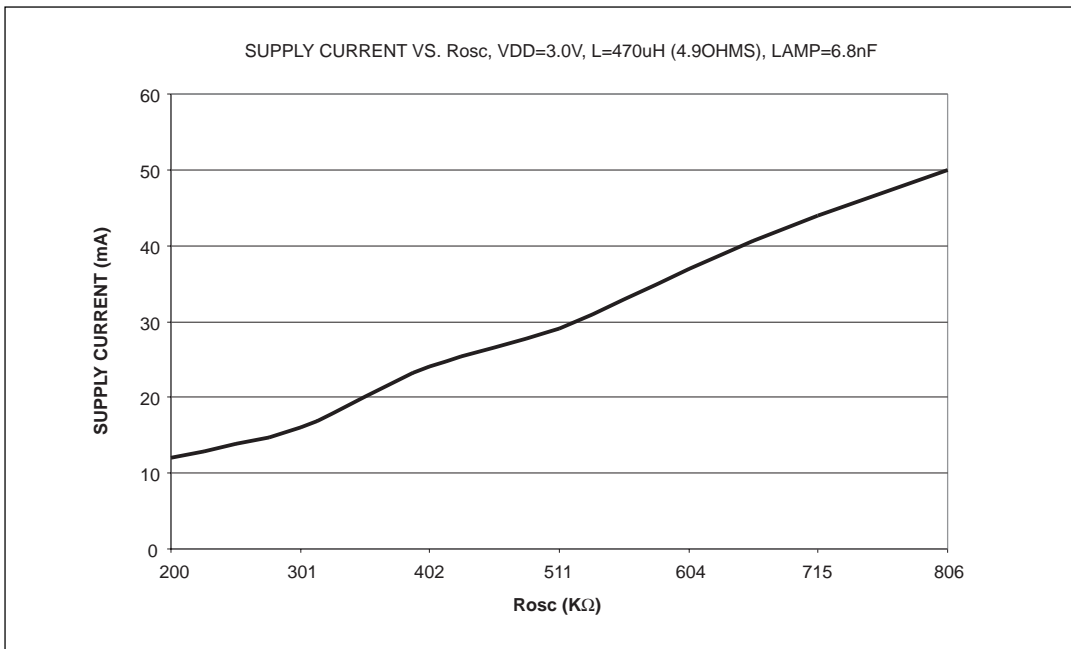

Figure 8: I_{TOTAL} vs R_{OSC} $V_{DD}=3.0V$, Coil=470 μ H, 4.9 Ω

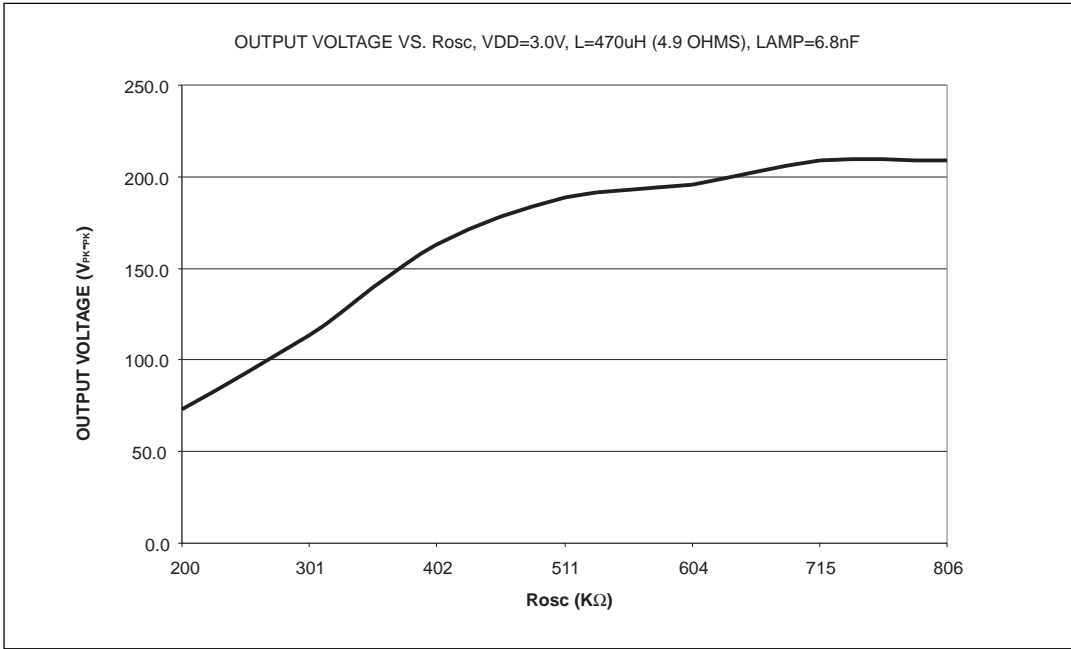

Figure 9: Output Voltage vs R_{OSC} , $V_{DD}=3.0V$, $Coil=470\mu H$, 4.9Ω

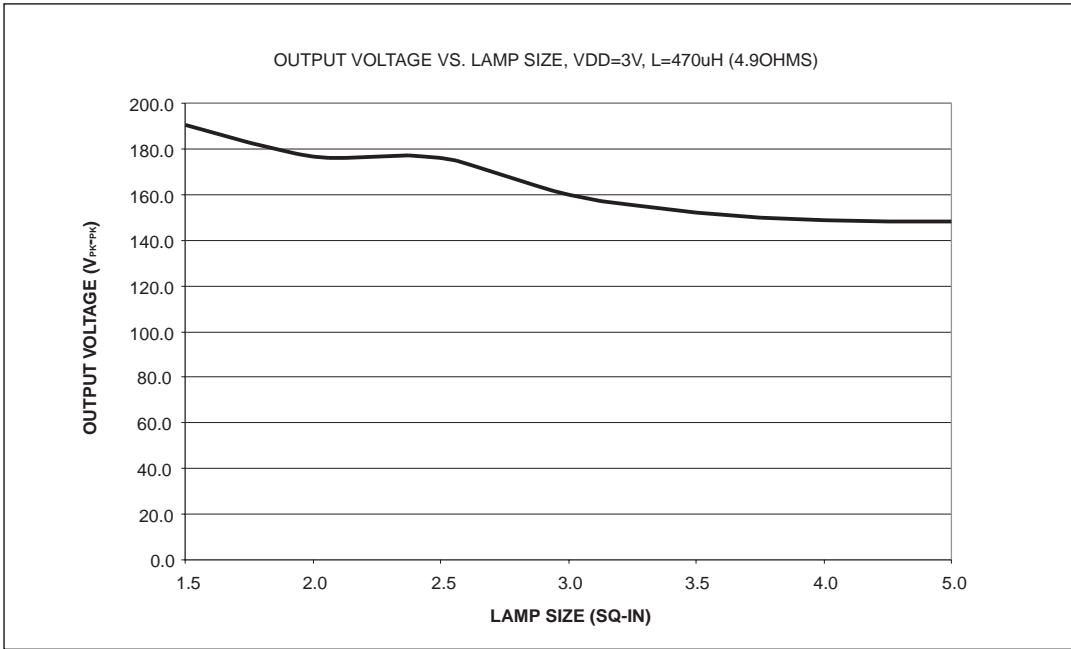

Figure 10: Output Voltage vs Lamp Size, $V_{DD}=3.0V$, $R_{OSC}=450k\Omega$, $Coil=470\mu H$, 4.9Ω

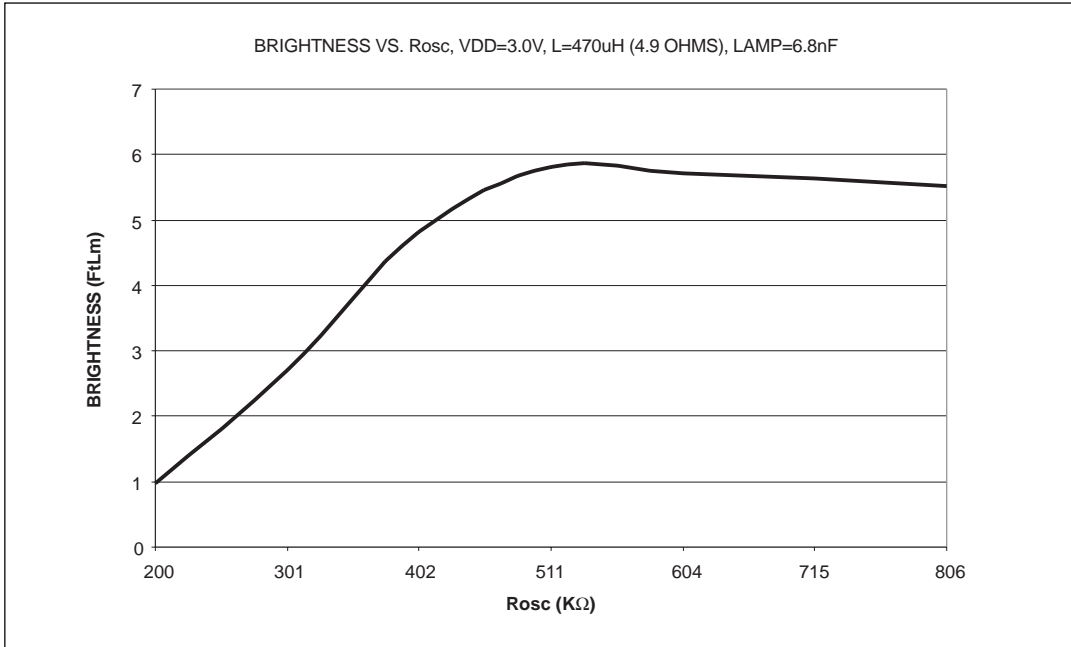

Figure 11: Luminance vs R_{osc} $V_{DD}=3.0V$, $Coil=470\mu H$, 4.9Ω

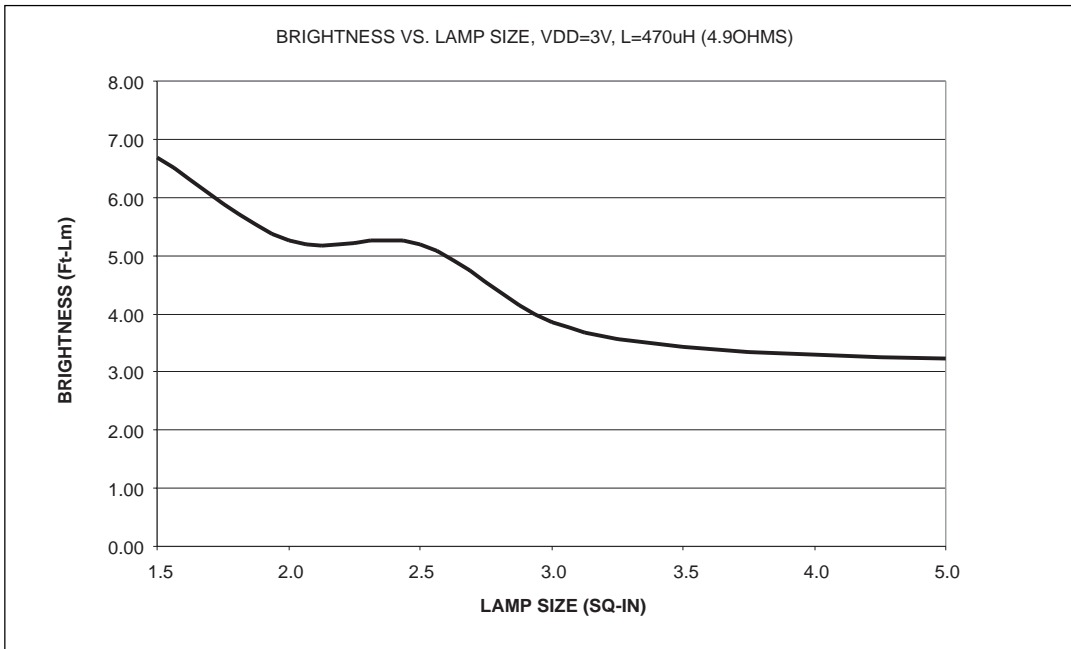

Figure 12: Luminance vs Lamp Size, $V_{DD}=3.0V$, $R_{osc}=450k\Omega$, $Coil=470\mu H$, 4.9Ω

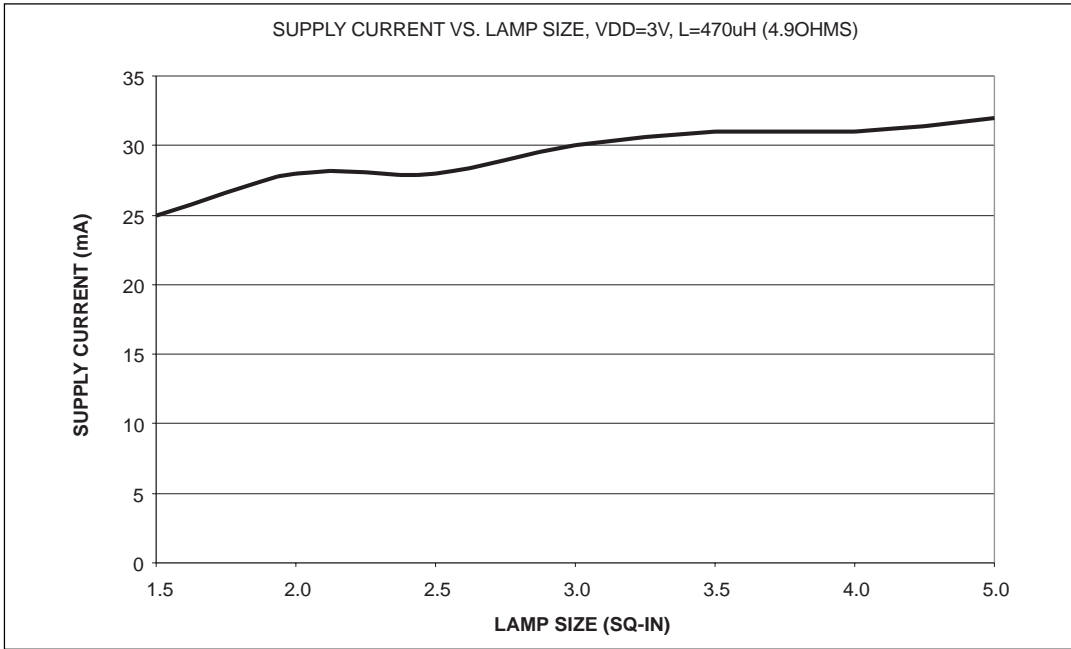
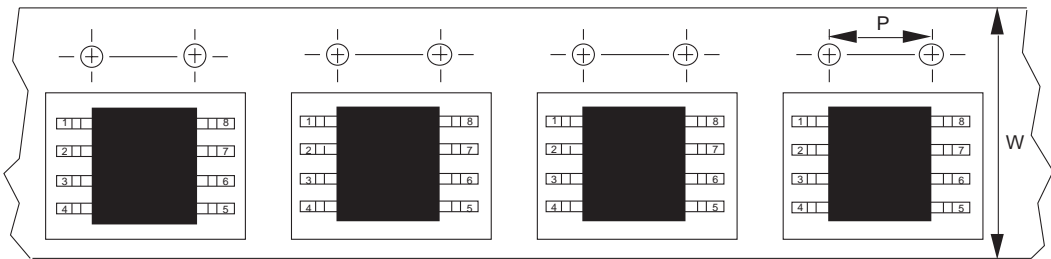
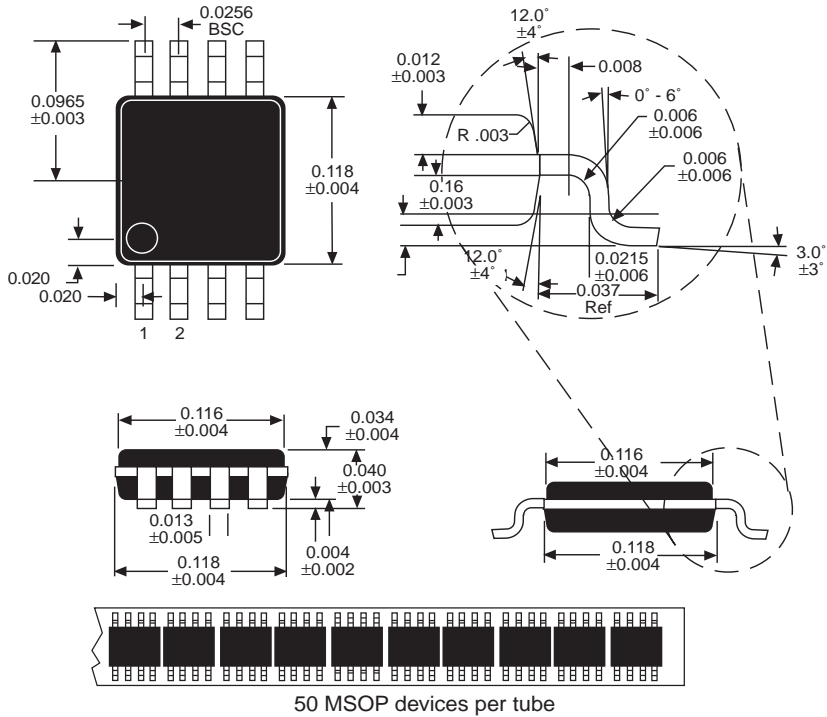

Figure 13: I_{TOTAL} vs Lamp Size, $V_{DD}=3.0V$, $R_{OSC}=450k\Omega$, Coil=470 μ H, 4.9 Ω

All package dimensions in inches

8-pin MSOP



8-pin MSOP 13" reels: P = 8mm, W = 12mm		
Package	minimum quantity per reel	standard quantity per reel
EU	500	2500

ORDERING INFORMATION

Model	Temperature Range	Package Type
SP4403EU	-40°C to +85°C	8-Pin MSOP
SP4403UEB		Evaluation Board



SIGNAL PROCESSING EXCELLENCE

Sipex Corporation

Headquarters and

Sales Office

22 Linnell Circle
Billerica, MA 01821
TEL: (978) 667-8700
FAX: (978) 670-9001
e-mail: sales@sipex.com

233 South Hillview Dr
Milpitas, CA 95053
TEL: (408) 934-7500
FAX: (408) 935-7600

Sipex Corporation reserves the right to make changes to any products described herein. Sipex does not assume any liability arising out of the application or use of any product or circuit described herein; neither does it convey any license under its patent rights nor the rights of others.